

Overview ..... 0

Cabinets ..... 1

Wall mounted cases ..... 2

Accessories for cabinets and wall mounted cases 3

Climate control 4

Desk-top cases 5

Subracks/  
19" chassis ... 6

Front panels,  
plug-in units .. 7

Systems ..... 8

Power supply  
units ..... 9

Backplanes .. 10

Connectors, front  
panel component  
system ..... 11

Appendix .... 12

## 19" chassis - *multipacPRO*



06005001

### Standards/certifications

- Exterior dimensions in accordance with: IEC 60297-3-100, 101, 105
- Ingress protection IP 20 in accordance with IEC 60529
- EMC testing in accordance with VG 95373 part 15 or IEC 61587



06008009

Handles can be bolted on from front



06008010

High stability with aluminium profile side panel

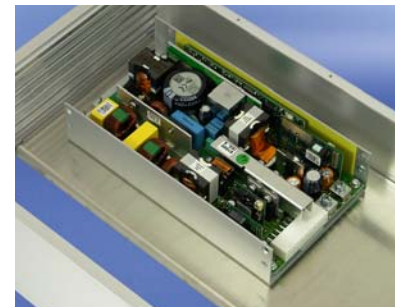

06008011

Mounting plate for fitting heavy components

### Top cover and base plate in 3 versions



06008003

Plain



06008005

Perforated



06008004

For standardised board mounting



Downloads and further important information can be found on the Internet under [www.schroff.biz](http://www.schroff.biz)

## The ideal solution for electronic devices in the most compact dimensions

- Aluminium or steel (AlZn coated) designs
- For standardised 19" board mounting or for installation of non-standardised components
- EMC shielding upgradable
- Mounting service and customized machining with ServicePLUS



06008005

### 19" complete chassis

- 2 materials
  - Steel plate (AlZn coated)
  - Aluminium
- 3 top cover versions
  - Top cover/base plate, solid
  - Top cover/base plate, perforated (aluminium version)
  - Top cover/base plate for standardised PCBs (aluminium version)



06008001

### 19" chassis, individually configured from separate parts

- For non-standardised assemblies with mounting plate
- For standardised board assembly
- Customised solutions

19" complete chassis (St) . . . . 6.114  
 19" complete chassis (Al) . . . . 6.115

19" chassis for non-standardised assembly . . . . . 6.120  
 19" chassis for standardised assembly . . . . . 6.122

**Accessories**  
 Guide rails . . . . . 6.124  
 Telescopic slides  
 1 U . . . . . 6.125  
 Telescopic slides  
 2 U . . . . . 6.126



### ServicePLUS from page 6.118

- e.g. individual configuration and assembly
- e.g. modification (cut-outs)
- e.g. downloads (CAD drawings, user manuals, test reports)
- e.g. custom solutions (special sizes)

30407004

[www.schroff.biz/ServicePLUS](http://www.schroff.biz/ServicePLUS)

**FRONT PANEL EXPRESS**

ServicePLUS . . 6.118

Application examples . . . . . 6.127

# 19" chassis - *multipacPRO*

19" complete chassis from steel with plain top cover and base plate

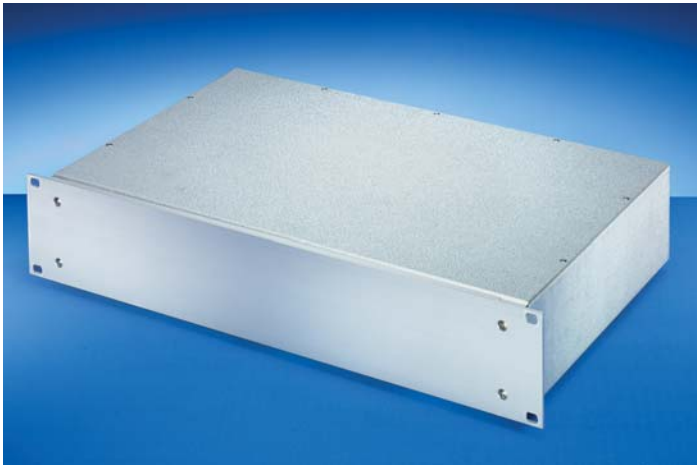

- Complete chassis, St (AlZn coated) with Al extrusion front panel
- Detachable rear panel for easy machining
- EMC shielding of approx. 30 dB(A) at 1 GHz (without additional shielding material)
- In accordance with standard IEC 60297-3-101
- In the 1 U version 19" and ATX power supplies can be assembled up to a clearance of 40 mm

### Delivery comprises (Kit)

Item	Qty	Description
1	1	Front panel, Al extrusion, 3 mm; in 1 U: front anodised, rear etched; from 2 U: front and rear side of front panels clear passivated
2	1	Base body, plain, St, 1 mm, (AlZn coated)
3	1	Rear panel, St, 1 mm (AlZn coated)
4	1	Cover, plain, St, 1 mm (AlZn coated)
5	1	Assembly kit

### Order Information

Height U	Height H mm	Depth T mm	Part no.
1	43.7	220	20860-120
1	43.7	280	20860-121
1	43.7	340	20860-122
2	88.1	280	20860-126
2	88.1	340	20860-127

### Accessories

<b>Front handles</b> incl. assembly kit for 1 U, Al extrusion, anodised, PU 2 pieces	20860-256
<b>Front handles</b> incl. assembly kit for 2 U, Al extrusion, anodised, PU 2 pieces	20860-257
<b>EMC sealing</b> to close the gap at the front between case and front panel, 2 saw tooth gaskets, stainless steel, PU 1 piece	20860-132

### Note

- Further versions with steel front panel (pizza box) available on request
- Telescopic slides cannot be used
- No special EMC version available
- Standardised internal mounting kits cannot be used



For further information [www.schroff.biz/oneclick](http://www.schroff.biz/oneclick)  
oneClick search code = Part no.

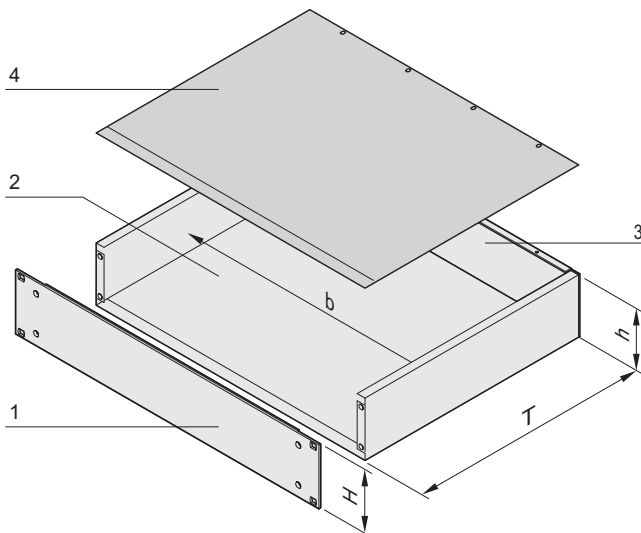

h = clear height (overall) (H - 3.0 mm)  
b = clear installation width = 447 mm

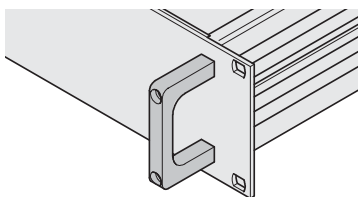

Front handle

06002052



ServicePLUS see page 6.118

# 19" chassis - *multipacPRO*

19" complete chassis from aluminium with plain top cover and base plate



06008003

- Complete chassis from aluminium
- Detachable rear panel for easy machining
- EMC shielding of approx. 30 dB(A) at 1 GHz (without additional shielding material)
- In accordance with standard IEC 60297-3-100, -101, -105
- In the 1 U version 19" and ATX power supplies can be assembled up to a clearance of 35 mm

### Delivery comprises (Kit)

Item	Qty	Description
1	1	Front panel, Al extrusion, 3 mm; in 1 U: front anodised, rear etched; from 2 U: front and rear side of front panels clear passivated
2	1	Rear panel, Al, 2 mm, etched
3	1	Base plate, plain, Al, 1 mm
4	1	Cover plate, plain, Al, 1 mm
5	2	Side panel, Al extrusion, raw; with grooves for threaded insert (2 x 7); 5 U, two-piece, 3+2 U
6	1	Assembly kit

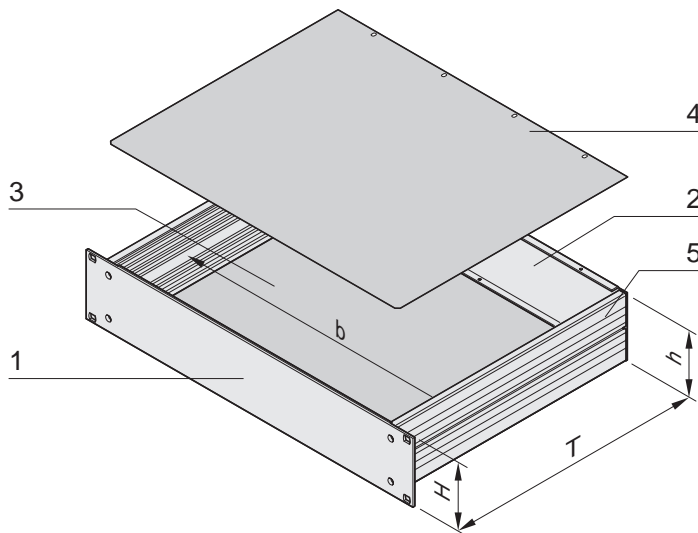

06008052

h = clear height (overall) (H - 8.1 mm)  
b = clear installation width = 403 mm

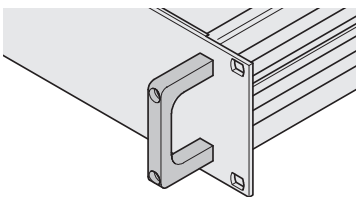

06002052

Front handle



ServicePLUS see page 6.118

### Order Information

Height U	Height H mm	Depth T mm	Part no. Kit
1	43.7	220	20860-601
1	43.7	280	20860-602
2	88.1	280	20860-605
2	88.1	340	20860-606
3	132.6	280	20860-607
3	132.6	340	20860-608
3	132.6	400	20860-609
4	177.0	340	20860-612
4	177.0	400	20860-613
4	177.0	460	20860-614
5	221.5	460	20860-615

**EMC gasketing kit** Silicone/nickel gasket 2100 mm for contacting side panel/cover plate; seal, stainless steel, for front panel/cover plate, 1 kit 20860-130

**Front handles** incl. assembly kit for 1 U, Al extrusion, anodised, PU 2 pieces 20860-256

**Front handles** incl. assembly kit for 2 U, Al extrusion, anodised, PU 2 pieces 20860-257

**Front handles** incl. assembly kit for 3 U, Al extrusion, anodised, PU 2 pieces 20860-258

**Front handles** incl. assembly kit for 4 U, Al extrusion, anodised, PU 2 pieces 20860-259

**Front handles** incl. assembly kit for 5 U, Al extrusion, anodised, PU 2 pieces 20860-260

### Note

- Threaded inserts to push into the side panel see page 6.121
- Telescopic slides to mount into cabinet see page 6.125

# 19" chassis - *multipacPRO*

19" complete chassis from aluminium with perforated top cover and base plate



06008005

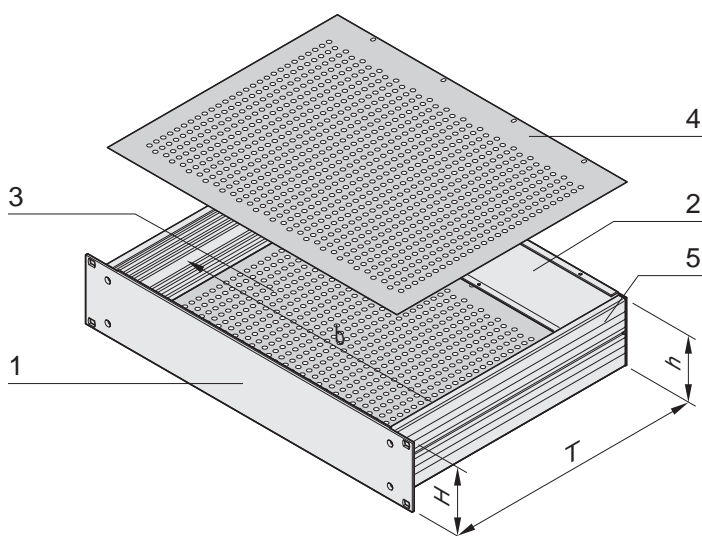

06008051

h = clear height (overall) (H - 8.1 mm)  
b = clear installation width = 403 mm

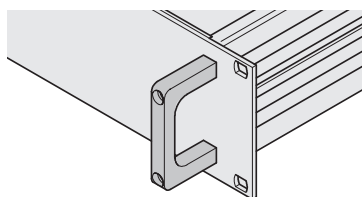

06002052

Front handle



ServicePLUS see page 6.118

- Complete chassis from aluminium
- Detachable rear panel for easy machining
- In the 1 U version 19" and ATX power supplies can be assembled up to a clearance of 35 mm
- EMC shielding of approx. 30 dB(A) at 1 GHz (without additional shielding material)
- In accordance with standard IEC 60297-3-100, -101, -105

## Delivery comprises (kit)

Item	Qty	Description
1	1	Front panel, Al extrusion, 3 mm; in 1 U: front anodised, rear etched; from 2 U: front and rear side of front panels clear passivated
2	1	Rear panel, Al, 2 mm, etched
3	1	Base plate, perforated, Al, 1 mm
4	1	Cover plate, perforated, Al, 1 mm
5	2	Side panel, Al extrusion, raw; with grooves for threaded insert (2 x 7); 5 U, two-piece, 3+2 U
6	1	Assembly kit

## Order Information

Height U	Height H mm	Depth T mm	Part no.
1	43.7	220	20860-621
1	43.7	280	20860-622
2	88.1	280	20860-625
2	88.1	340	20860-626
3	132.6	280	20860-627
3	132.6	340	20860-628
3	132.6	400	20860-629
4	177.0	340	20860-632
4	177.0	400	20860-633
4	177.0	460	20860-634
5	221.5	460	20860-635

**EMC gasketing kit** Silicone/nickel gasket 2100 mm for contacting side panel/cover plate; seal, stainless steel, for front panel/cover plate, 1 kit 20860-130

**Front handles** incl. assembly kit for 1 U, Al extrusion, anodised, PU 2 pieces 20860-256

**Front handles** incl. assembly kit for 2 U, Al extrusion, anodised, PU 2 pieces 20860-257

**Front handles** incl. assembly kit for 3 U, Al extrusion, anodised, PU 2 pieces 20860-258

**Front handles** incl. assembly kit for 4 U, Al extrusion, anodised, PU 2 pieces 20860-259

**Front handles** incl. assembly kit for 5 U, Al extrusion, anodised, PU 2 pieces 20860-260

## Note

- Threaded inserts to push into the side panel see page 6.121
- Telescopic slides to mount into cabinet see page 6.125



For further information [www.schroff.biz/oneclick](http://www.schroff.biz/oneclick)  
oneClick search code = Part no.

# 19" chassis - *multipacPRO*

19" complete chassis from aluminium, for assembly of euroboards



06008004

- Complete chassis from aluminium
- Detachable rear panel for easy machining
- EMC shielding of approx. 30 dB(A) at 1 GHz (without additional shielding material)
- In accordance with standard IEC 60297-3-100, -101, -105
- In the 1 U version 19" and ATX power supplies can be assembled up to a clearance of 35 mm

### Delivery comprises (Kit)

Item	Qty	Description
1	1	Front panel Al extrusion, 3 mm; in 1 U: front anodised, rear etched; from 2 U: front and rear side of front panels clear passivated
2	1	Rear panel, Al, 2 mm, etched
3	1	Base plate, Al, 1 mm; with drilled holes for horizontal mounting of euroboards
4	1	Cover plate, Al, 1 mm; with drilled holes for horizontal mounting of euroboards
5	2	Side panel, Al extrusion, raw; with grooves for threaded insert (2 x 7)
6	1	Assembly kit

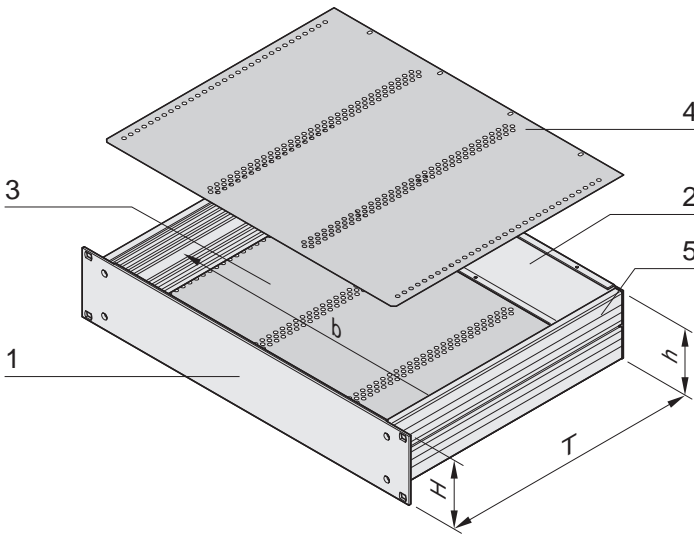

06008050

h = clear height (overall) (H - 8.1 mm)  
b = clear installation width = 403 mm

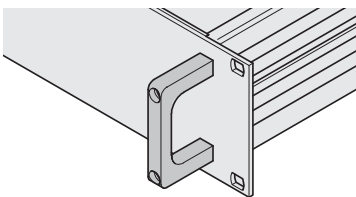

06002052

Front handle



ServicePLUS see page 6.118

### Order Information

Height U	Height H mm	Depth T mm	Part no.
1	43.7	220	20860-641
1	43.7	280	20860-642
2	88.1	280	20860-645
<b>EMC gasketing kit</b> PU 1 kit			20860-130
<b>Front handles</b> for 1 U PU 2 pieces			20860-256
<b>Front handles</b> for 2 U PU 2 pieces			20860-257
<b>Euroboard mounting kit for EN 60603 connector</b> for 1 U PU 1 kit			20860-115
<b>Euroboard mounting kit for EN 60603 connector</b> for 2 U PU 1 kit			20860-117
<b>Euroboard mounting kit for insulated backplane mounting</b> for 1 U PU 1 kit			20860-116
<b>Euroboard mounting kit for insulated backplane mounting</b> for 2 U PU 1 kit			20860-118

### Note

- Threaded inserts to push into the side panel see page 6.121
- Guide rails see page 6.124
- Telescopic slides to mount into cabinet see page 6.125



For further information [www.schroff.biz/oneclick](http://www.schroff.biz/oneclick)  
OneClick search code = Part no.

## 19" chassis - *multipacPRO* ServicePLUS



### configuration

Simple. Fast. For the product you want.

**Components can be varied and combined freely**

- Configuration tables from page 6.119
- Online configuration: [www.schroff.co.uk/configuration](http://www.schroff.co.uk/configuration)



### assembly

Assembled by professionals. Double benefit!

**Fitting of all mechanical, electrical and electronic components by our specialists**

- Professional and reliable from quantity 1
- Ready for despatch within 5 working days



### modification

Small changes. Large impact.

**Custom drillings, cut-outs and special colours for off-the-shelf products**

- Custom modifications from quantity 1
- Ready for despatch within 10 working days

**FRONTPLATTEN  
EXPRESS**



### solution

Simple. Fast. From one source.

**Integration and custom developments**

- Special sizes (depth and width)
- Individual heat dissipation concepts
- Ready for dispatch within 10 working days



### express

When fast has to be faster.

**Delivery time to customer's request**

- Express logistics



### academy

Knowledge. Sharing. Partnerships.

**Knowledge transfer and partnership**

- Seminars, CAD drawings, test reports, user reports

## 19" chassis - *multipacPRO* ServicePLUS

### How to configure 19" aluminium chassis

- Select height and depth of the basic kit
- Select further components

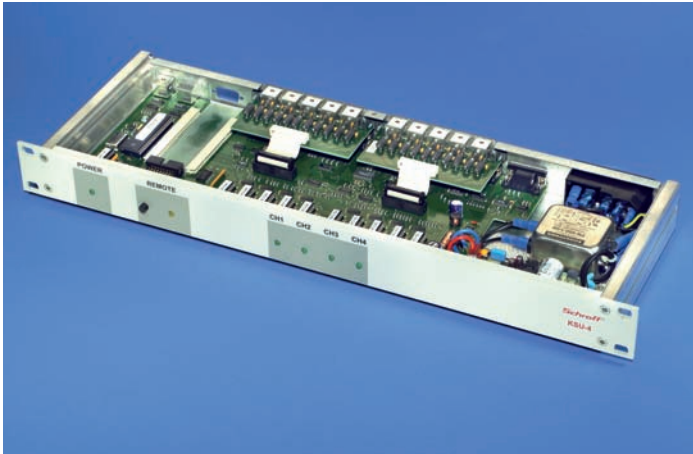

06006001

### For non-standardised assemblies (1 ... 5 U)

- Mounting plate
- Top cover/base plate
- Front handles
- EMC gasketing kit
- Telescopic slides

#### Note

- Non-standardised assemblies see from page 6.120

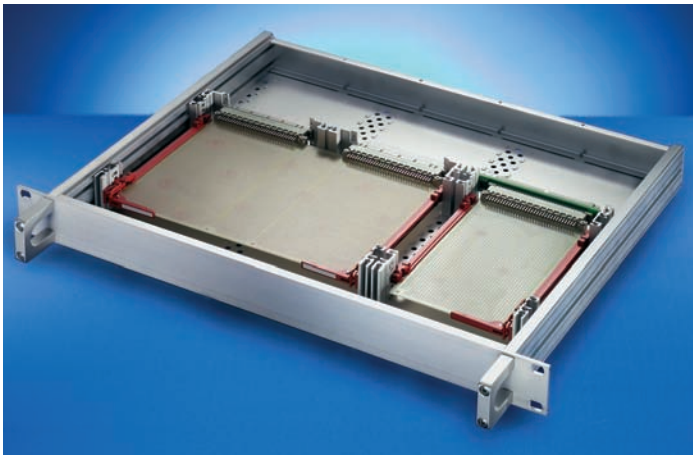

06002001

### For standardised assemblies (1, 2 U) in accordance with IEC 60297 -3-100, -101, -105

- Top cover/base plate for horizontal board mounting
- Internal connector or backplane fitting
- Front handles
- EMC gasketing kit
- Telescopic slide

#### Note

- Standardised assemblies from page 6.122



# 19" chassis - *multipacPRO* ServicePLUS

## Individual components 19" chassis for non-standardised assemblies

- Please select:
  - Height and depth of basic kit (1 ... 5 U, item 1+2+5)
  - Mounting plate
  - Top cover/base plate (item 3+4)
  - Front handles
  - EMC gasketing kit
  - Telescopic slides
- In accordance with IEC 60297-3-105

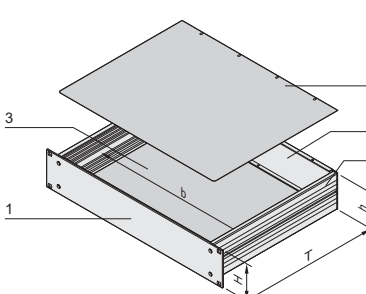
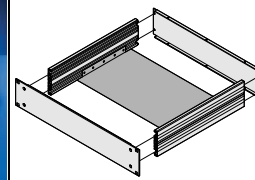
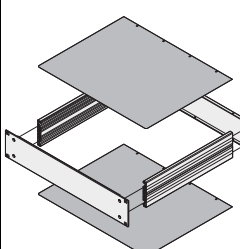
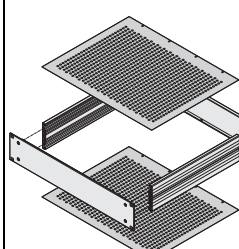

### Order Information

Height U	Height mm	Width HP	Depth mm	Basic kit		Mounting plate		Top cover/base plate			
				06008052		06002004		plain	perforated		
				 <p><b>h = clear height (overall) (H - 8.1 mm)</b> <b>b = clear installation width = 403 mm</b></p>		 <p>Al plate, 2 mm; threaded insert, St, 2 mm, zinc-plated, height 7 mm, length 431.3 mm, M3 hole clearance 1 HP = 5.08 mm; for heavy equipment</p>		 <p>is inserted into the basic kit, Al, 1 mm, passivated; please order EMC gasketing kit separately</p>		 <p>is inserted into the basic kit, Al, 1 mm, passivated; hole diameter 4 mm, perforation ratio 58 %</p>	
				<p>1 x Al front panel, 3 mm; 2 x extruded Al side panels; 1 x Al rear panel, 2 mm, incl. fixing material kit</p>							
				<p><b>PU 1 kit</b></p>		<p><b>Depth mm</b></p>		<p><b>1 piece</b></p>			
1	43.7	84	220	<b>20860-201</b>	150	<b>20860-107</b>	<b>30860-501</b>	<b>30860-510</b>			
1	43.7	84	280	<b>20860-202</b>	210	<b>20860-108</b>	<b>30860-502</b>	<b>30860-511</b>			
1	43.7	84	340	<b>20860-203</b>	270	<b>20860-109</b>	<b>30860-503</b>	<b>30860-512</b>			
2	88.1	84	220	<b>20860-210</b>	150	<b>20860-107</b>	<b>30860-501</b>	<b>30860-510</b>			
2	88.1	84	280	<b>20860-211</b>	210	<b>20860-108</b>	<b>30860-502</b>	<b>30860-511</b>			
2	88.1	84	340	<b>20860-212</b>	270	<b>20860-109</b>	<b>30860-503</b>	<b>30860-512</b>			
3	132.6	84	280	<b>20860-219</b>	210	<b>20860-108</b>	<b>30860-502</b>	<b>30860-511</b>			
3	132.6	84	340	<b>20860-220</b>	270	<b>20860-109</b>	<b>30860-503</b>	<b>30860-512</b>			
3	132.6	84	400	<b>20860-221</b>	330	<b>20860-110</b>	<b>30860-504</b>	<b>30860-513</b>			
3	132.6	84	460	<b>20860-222</b>	390	<b>20860-111</b>	<b>30860-505</b>	<b>30860-514</b>			
4	177.0	84	280	<b>20860-228</b>	210	<b>20860-108</b>	<b>30860-502</b>	<b>30860-511</b>			
4	177.0	84	340	<b>20860-229</b>	270	<b>20860-109</b>	<b>30860-503</b>	<b>30860-512</b>			
4	177.0	84	400	<b>20860-230</b>	330	<b>20860-110</b>	<b>30860-504</b>	<b>30860-513</b>			
4	177.0	84	460	<b>20860-231</b>	390	<b>20860-111</b>	<b>30860-505</b>	<b>30860-514</b>			
5	221.5	84	460	<b>20860-240</b>	390	<b>20860-111</b>	<b>30860-505</b>	<b>30860-514</b>			

# 19" chassis - *multipacPRO* ServicePLUS

Individual components 19" chassis for non-standardised assemblies

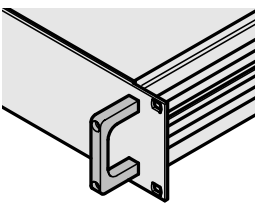
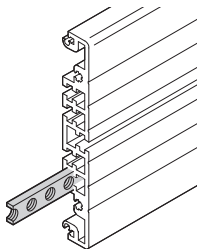
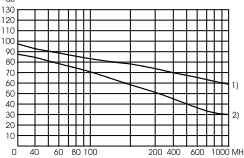
## Order Information

				Front handles	Threaded insert M3 for extruded side panel	EMC gasketing kit Shielding upgrade of approx. 30 dB	Assembly kit for telescopic slides
							
				06002052	06007051	esa44237	06094004
				Al extrusion, anodised, incl. assembly kit see page 5.108	St, 2 mm, zinc-plated, height 7 mm, length 431.3 mm, M3 hole clearance 1 HP = 5.08 mm	Gasket 2100 mm, silicone/nickel, for contacting side panel/ top cover and base plate; sawtooth gasket 400 mm; stainless steel, for contacting front panel/ top cover and base plate	Assembly kit and adaptor bracket for the cabinets VARISTAR, eurorack, minirack; for mounting the 19in. chassis on telescopic slides; please order telescopic slides separately see page 6.125
Height U	Height mm	Width HP	Depth D mm	PU 2 pieces	1 piece	PU 1 kit	PU 1 kit
1	43.7	84	220	20860-256	30821-589	20860-130	20860-131
1	43.7	84	280				
1	43.7	84	340				
2	88.1	84	220	20860-257			
2	88.1	84	280				
2	88.1	84	340				
3	132.6	84	280	20860-258			
3	132.6	84	340				
3	132.6	84	400				
3	132.6	84	460	20860-259			
4	177.0	84	280				
4	177.0	84	340				
4	177.0	84	400				
4	177.0	84	460	20860-260			
5	221.5	84	460				

### Note

- Further sizes available on request
- Al extrusion side panels up to 1000 mm length available on request
- Telescopic slides see page 6.125

# 19" chassis - *multipacPRO* ServicePLUS

**Individual components** 19" chassis for standardised 19" assemblies

- Please select
  - Height and depth of basic kit (1, 2 U, items 1+2+5)
  - Top cover/base plate for horizontal board mounting (items 3+4)
  - Internal mounting for connector or backplane
  - Front handles
  - EMC gasketing kit
  - Telescopic slides
- In accordance with IEC 60297-3-100, 101, 105

## Order Information

Height U	Height mm	Width HP	Depth D mm	Basic kit	Top cover/base plate	Mounting of euroboards for EN 60603 connectors	Mounting of euroboards for insulated backplane assembly
				06008052 1 x Al front panel, 3 mm; 2 x extruded Al side panels; 1 x Al rear panel, 2 mm, incl. fixing material kit	06002004 Al, 1 mm; with drilled holes for horizontal mounting of euroboards	06008053 2 x front horizontal rails, 2 x rear horizontal rails with Z, 2 x threaded inserts; Sufficient for one 3 U board or one 6 U board	06003051 2 x front horizontal rails, 2 x rear horizontal rails, 4 x threaded inserts, 4 x insulation strips PBT, UL 94; Sufficient for one 3 U board or one 6 U board (6 HP for 1 U, 15 HP for 2 U)
				<b>PU 1 kit</b>	<b>1 piece</b>	<b>PU 1 kit</b>	<b>PU 1 kit</b>
1	43.7	84	220	20860-201	30860-519	20860-115	20860-116
1	43.7	84	280	20860-202	30860-520	20860-115	20860-116
1	43.7	84	340	20860-203	30860-521	20860-115	20860-116
2	88.1	84	220	20860-210	30860-519	20860-117	20860-118
2	88.1	84	280	20860-211	30860-520	20860-117	20860-118
2	88.1	84	340	20860-212	30860-521	20860-117	20860-118

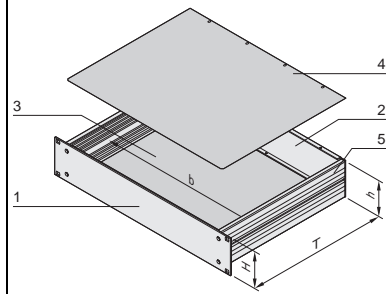

**h = clear height (overall) (H - 8.1 mm)**  
**b = clear installation width = 403 mm**

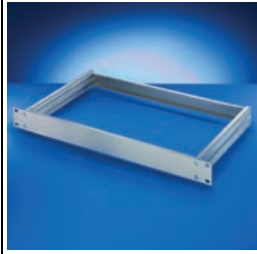

1 x Al front panel, 3 mm;  
2 x extruded Al side panels;  
1 x Al rear panel, 2 mm,  
incl. fixing material kit

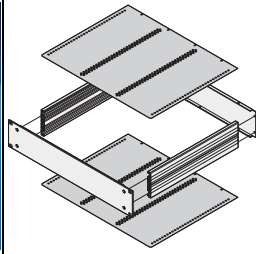

Al, 1 mm; with drilled holes for horizontal mounting of euroboards

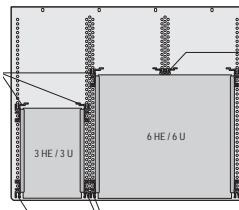

2 x front horizontal rails,  
2 x rear horizontal rails with Z,  
2 x threaded inserts;  
Sufficient for one 3 U board or one 6 U board

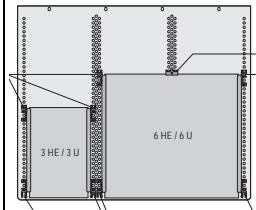



2 x front horizontal rails,  
2 x rear horizontal rails,  
4 x threaded inserts,  
4 x insulation strips PBT, UL 94;  
Sufficient for one 3 U board or one 6 U board (6 HP for 1 U, 15 HP for 2 U)

# 19" chassis - *multipacPRO* ServicePLUS

Individual components 19" chassis for standardised 19" assemblies

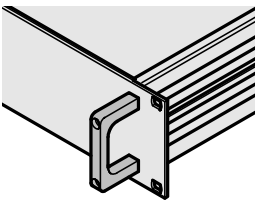
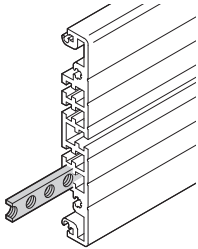
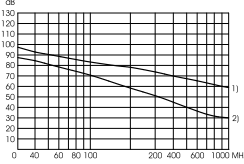
## Order Information

				Front handles	Threaded insert M3 for extruded side panel	EMC gasketing kit for shielding upgrade of approx. 30 dB	Assembly kit for fixing on telescopic slides
							
				06002052	06007051	esa44237	06094004
				Al extrusion, anodised, incl. assembly kit see page 5.108	St, 2 mm, zinc-plated, height 7 mm, length 431.3 mm, M3 hole clearance 1 HP = 5.08 mm	Gasket 2100 mm, silicone/nickel, for contacting side panel/ top cover and base plate; sawtooth gasket 400 mm; stainless steel, for contacting front panel/ top cover and base plate	Assembly kit and adaptor bracket for the cabinets VARISTAR, eurorack, minirack; for mounting the 19in. chassis on telescopic slides; please order telescopic slides separately see page 6.125
Height U	Height mm	Width HP	Depth D mm	PU 2 pieces	1 piece	PU 1 kit	PU 1 kit
1	43.7	84	220	20860-256	30821-589	20860-130	20860-131
1	43.7	84	280				
1	43.7	84	340				
2	88.1	84	220	20860-257	30821-589	20860-130	20860-131
2	88.1	84	280				
2	88.1	84	340				



### Note

- Further sizes available on request
- Al extrusion side panels up to 1000 mm length available on request
- Telescopic slides see page 6.125

# 19" chassis - *multipacPRO* ServicePLUS

Guide rails for boards without front panels, one-piece, groove width 2 mm

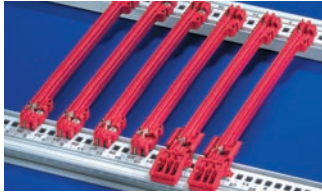
## Order Information

<b>Assembly</b> - can be clipped into horizontal rails in Al extrusion - can be clipped into 1.5 mm thick plate			<b>Guide rails</b> <b>"Accessories"</b>  <p style="text-align: right;">06102002</p> <p>up to 280 mm length, PBT, UL 94 V-0;                  &gt; 280 mm length, multi-piece, end piece PBT, UL 94 V-0, middle section Al extrusion</p>	
<b>Storage temperature</b> from -40 °C ... +130 °C				
<b>Board length</b>	<b>Groove width</b>	<b>Colour</b>		
<b>mm</b>	<b>mm</b>	<b>mm</b>	<b>PU 10 pieces 2)</b>	
160	2	red	24560-373	
220	2	red	24560-374	
280	2	red	24560-375	
340	2	red	24560-376	
Retention screw, PU 100 pieces			24560-141	

2) Part no. includes one packing unit (PU); delivery is exclusively made in PU

## Guide rail accessories

## Order Information

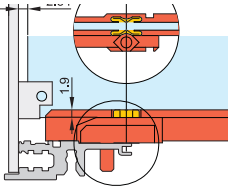
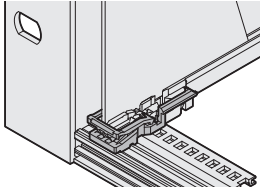
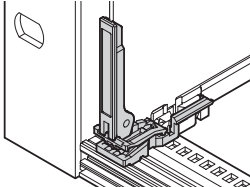
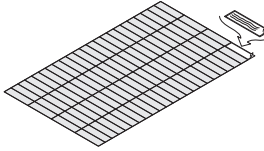
<b>ESD clip for guide rails</b>  <p style="text-align: right;">04503050</p> <p>Spring steel, tin-plated, ensures conductive contact between board and horizontal rail, on both the solder side and the component side</p> <p>PU 50 pieces 24560-255</p>	<b>Board locking for PCBs without front panel</b>  <p style="text-align: right;">04805050</p> <p>PBT, UL 94 V-0, red, to fix the PCB in the subrack (also slot 1), can also be used without board handle, minimum distance 3 HP</p> <p>PU 10 pieces 24560-377</p>	<b>Board handle for board locking</b>  <p style="text-align: right;">04805051</p> <p>PBT, UL 94 V-0, red, insertion/extraction function with connection to board locking (also slot 1), mounting directly behind front panel (upper and lower), minimum distance 3 HP</p> <p>PU 10 pieces 24560-378</p>	<b>Identification strips for board handle</b>  <p style="text-align: right;">06108076</p> <p>Polyester film, 31 x 4 mm, self-adhesive, white/matt (1 A4 sheet contains 438 pieces) PBT, UL 94 V-0</p> <p>1 piece 60817-228</p>
--	---	---	---

# 19" chassis - *multipacPRO* ServicePLUS

## Universal 1 U telescopic slide

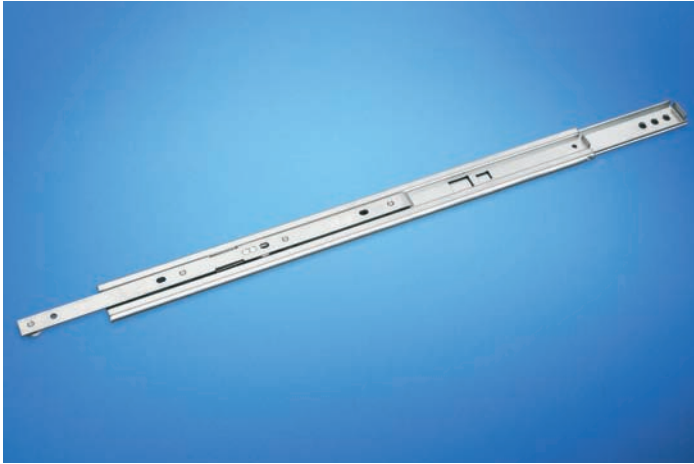

00505011

- Static load-carrying capacity per pair 23 - 39 kg
- Lateral mounting on the 19" uprights (19" plane remains free for fixing the extension/drawer)
- Can be removed
- Extension length > 100 %
- Rail width  $k = 9.7$  mm, max. installation width of extension/drawer  $w = 429$  mm

### Delivery comprises

Item	Qty	Description
1	2	Telescopic slide, St, zinc-plated

### Order Information

Length L	Extension length Y	Load-carrying capacity P	Part no.
356	381	39	20110-090
406	432	36	20110-091
457	483	34	20110-092
508	533	32	20110-093
559	584	29	20110-094
610	635	27	20110-095
660	686	23	20110-096
711	737	23	20110-097

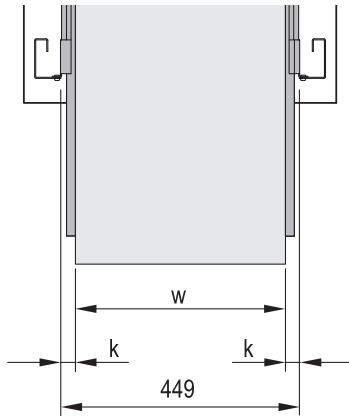

00505060

$k$  = rail width,  $w$  = max. installation width

### Dimensions table

L	Internal part								External part		
	A	B	C	D	E	F	G	X	O	P	Q
356	29.5	92.1	184.2	276.2	-	-	-	349.3	304.6	317.3	330.0
406	29.5	92.1	184.2	276.2	-	-	-	349.3	355.4	368.1	380.8
457	29.5	92.1	184.2	276.2	-	-	-	349.3	406.4	419.1	431.8
508	89.9	92.1	184.2	276.2	368.3	-	-	501.7	457.4	470.1	482.8
559	89.9	92.1	184.2	276.2	368.3	-	-	501.7	508.1	520.8	533.5
610	89.9	92.1	184.2	276.2	368.3	-	-	501.7	558.6	571.3	584.0
660	7.4	92.1	184.2	276.2	368.3	460.4	552.4	603.3	609.4	622.1	634.8
711	7.4	92.1	184.2	276.2	368.3	460.4	552.4	603.3	660.2	672.9	685.6

### Note

- For mounting into Schroff cabinets please order assembly kit separately, see page 6.123



For further information [www.schroff.biz/oneclick](http://www.schroff.biz/oneclick)  
oneClick search code = Part no.

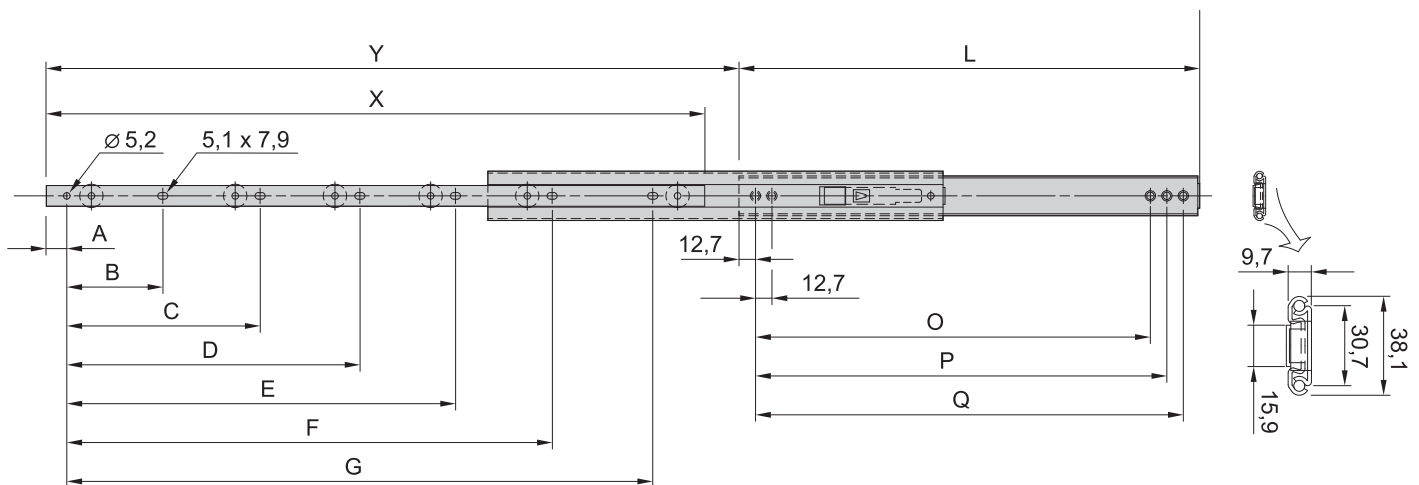

00505055

# 19" chassis - *multipacPRO* ServicePLUS

## Universal 2 U, slim telescopic slide



00505009

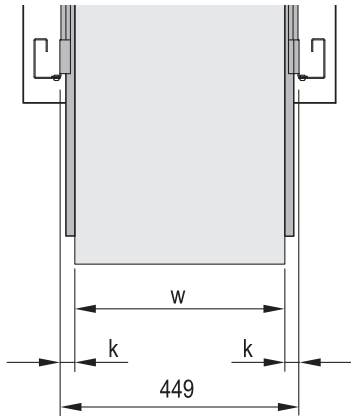

0050506000505059

k = rail width, w = max. installation width

### Dimensions table

Length L	Internal part				External part		
	A	w	C	X	D	E	F
356	101.6	184.2	304.8	356.0	101.6	228.6	330.2
406	127.0	209.6	355.6	406.0	127.0	254.0	381.0
457	127.0	235.0	406.4	457.0	152.4	279.4	431.8
508	152.4	260.4	457.2	508.0	152.4	330.2	482.6
559	203.2	412.8	508.0	559.0	177.8	355.6	533.4
584	203.2	431.8	533.4	584.0	177.8	381.0	558.8
610	203.2	438.2	558.8	610.0	203.2	381.0	584.2

- Static load-carrying capacity per pair 46 - 57 kg
- Lateral mounting on the 19" uprights (19" plane remains free for fixing the extension/drawer)
- Locking at full extension
- Extension length > 110 %
- Rail width k = 9,7 mm, max. installation width of extension/drawer w = 429 mm

### Delivery comprises

Item	Qty	Description
1	2	Telescopic slide, St, zinc-plated

### Order Information

Length L	Extension length Y	Load-carrying capacity P	Part no.
mm	mm	kg	
356	432	57	20110-071
406	483	55	20110-072
457	533	55	20110-073
508	584	55	20110-074
559	635	46	20110-075
584	660	46	20110-076
610	686	46	20110-077

### Accessories

<b>Assembly kit for VARISTAR,</b> for assembly of 2 telescopic slides, PU 1 kit	21120-161
<b>Assembly kit for eurorack,</b> for assembly of 2 telescopic slides, PU 1 kit	21120-162
<b>Telescopic slides mounting kit for NOVASTAR,</b> to mount 2 telescopic slides, PU 1 kit	21120-163
<b>Delivery: supplied loose with cabinet or frame</b>	<b>Part no./35</b>

### Note

- To mount on 19" plane please order assembly kit separately
- Universal telescopic rails can also be fitted without additional components in non-standard applications, thus also in other than 19" cabinets

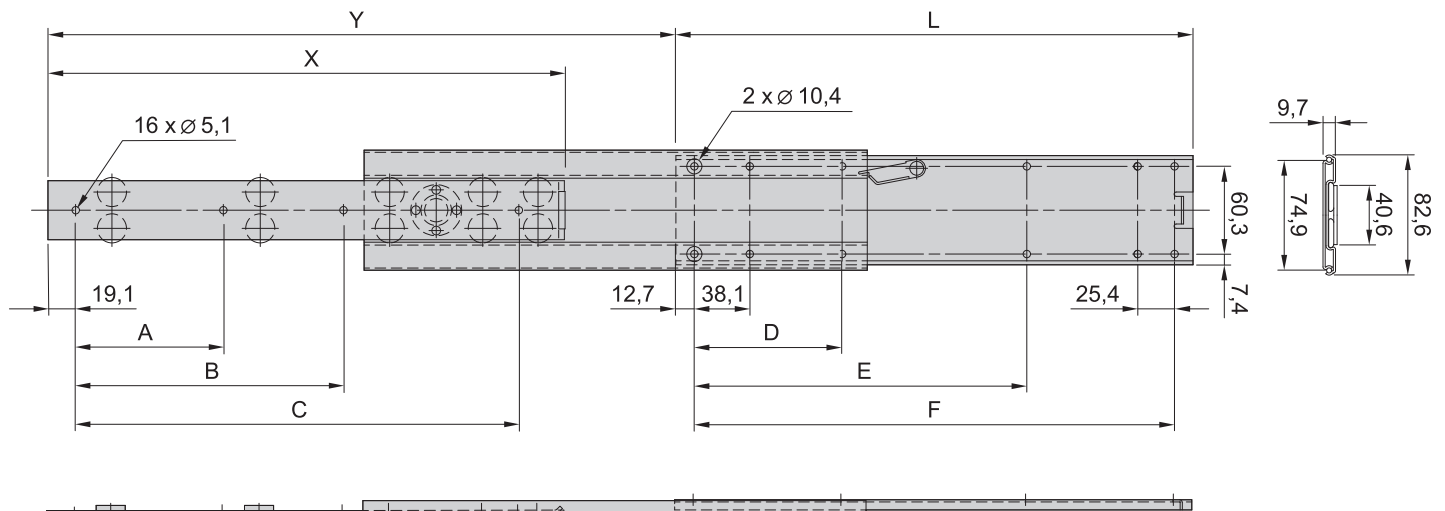

00505059

# 19" chassis - *multipacPRO* ServicePLUS

## Customised solutions



Application: Different cut-outs

06002006

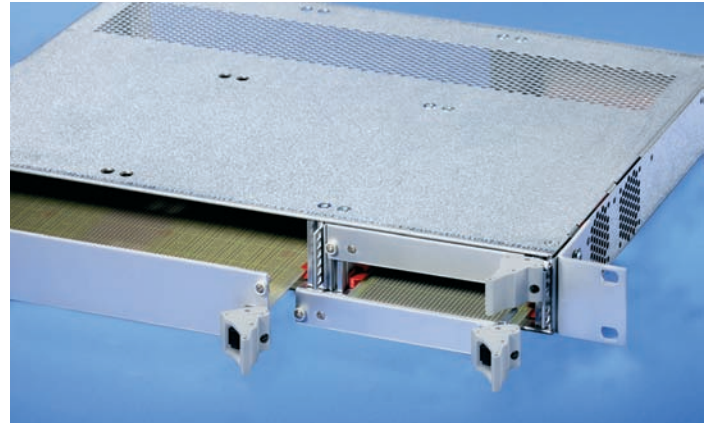

Application: Combined 3 U and 6 U assembly

06002007



Application: 2 U version with 2 x 3 U assembly

06002005



Application: 1 U multipacPRO (pizza box) complete from steel plate; 19" brackets can be removed if required

06008006



Application: 1 U multipacPRO complete from steel plate; front panel in aluminium with cut-outs

06108007



Application: 1 U multipacPRO complete from steel plate; printed 19" front panel in aluminium with cut-outs

06101008